

FITZROY BALL BEARING DOOR TRACKS

ALLOY MEDIUM A500a Accordion Track

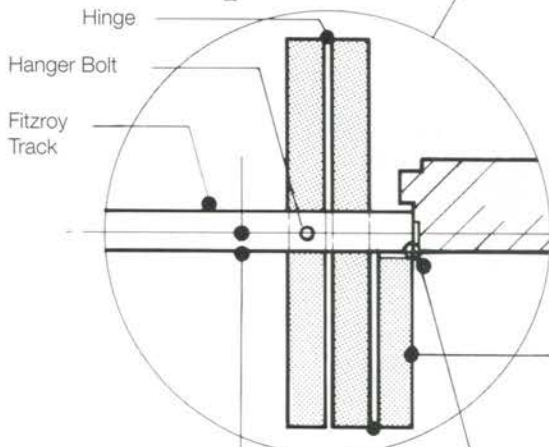
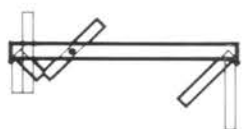
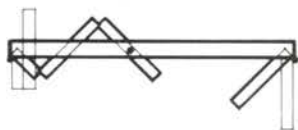
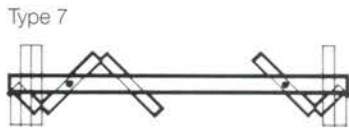
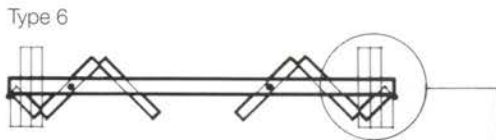
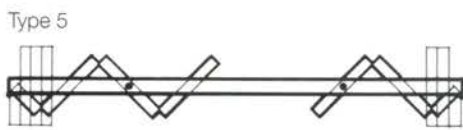
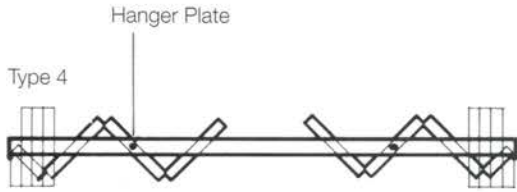

Very Important
 Note (1)
 Subtract half the door thickness from width of half doors

Note
 No offsets to butts on post

Set out on this page is an Accordion Door System using the Alloy Medium Fitzroy Door Track.

As for the bi-fold door, overleaf, the suggested maximum door leaf width is 1,000mm and the assembly weight should not exceed 100kg per hanger plate.

For best results good quality butt hinges should be used throughout. As shown in the diagrams at the left, up to 3½ doors can be swung at each side. Note the location of the hanger plates.

